

# DRAG2ZERO

## Mono Conversion Kit for Argon18 E-119Tri+ Disc



For use with Drag2Zero angled shims and risers

- Supplied with
  - 1 x Mono mounting plate
  - 2 x 30mm Countersunk bolts
- For Gen1 angled shims and pole clamp systems. Offset pole by 15mm either side. Poles can be set to widths of 60, 90, 120 or 150mm. 1.3 ° or 3.5 ° of toe options.

OR

- For Gen2 angled shims and pole clamp systems. Mounts directly above holes to provide pole widths of 90 or 120 with 6 ° of toe in pole clamp

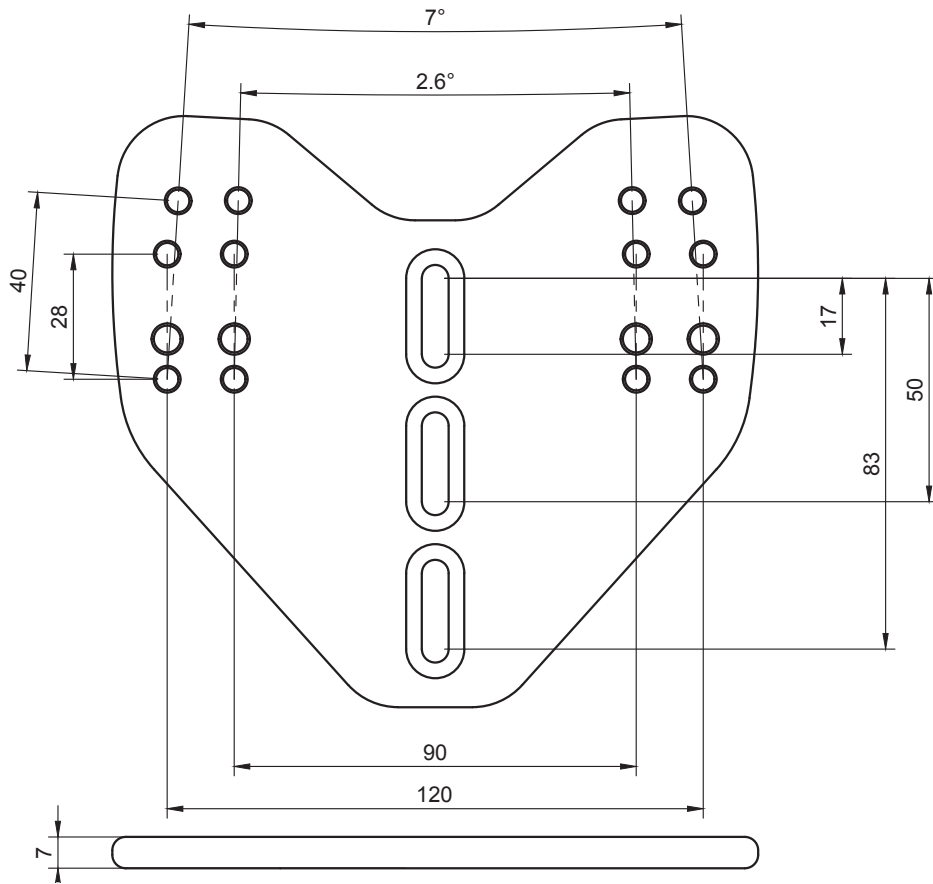

The mono plate needs to be mounted onto a 5mm Argon18 mono riser.  
Mono conversion bolts to be torqued to 6Nm

2 x 40mm counter-sunk bolts \*supplied

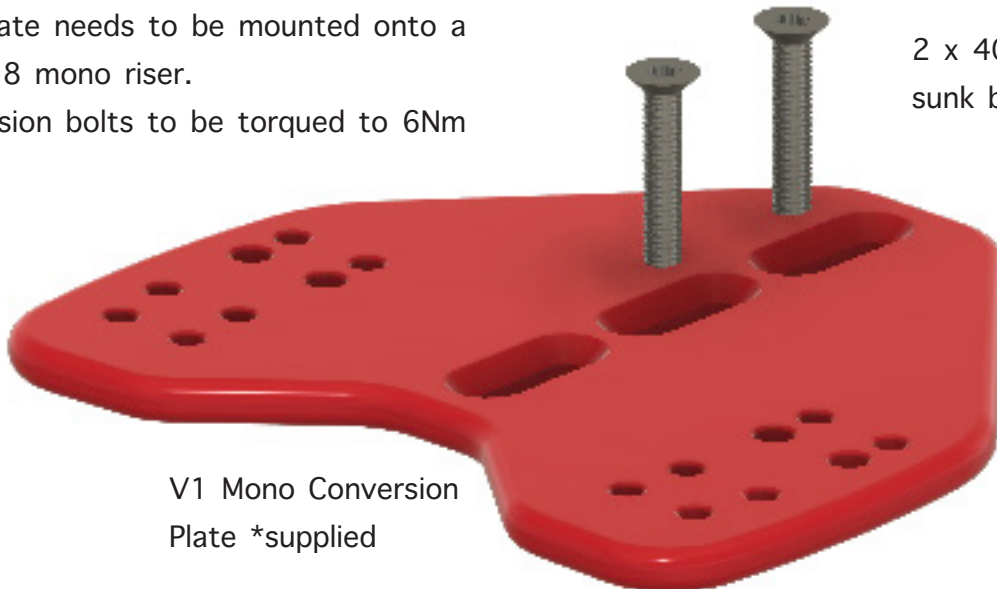

V1 Mono Conversion Plate \*supplied

Argon 18 10mm mono riser